

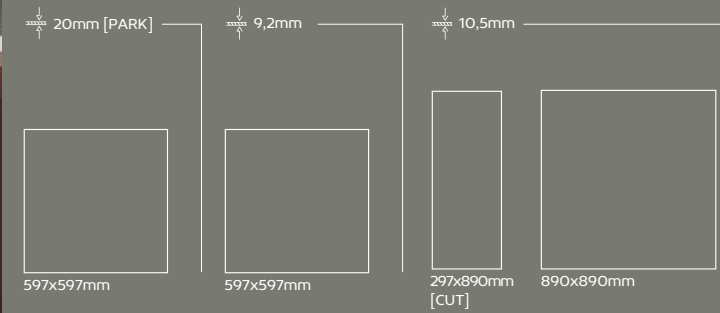

OXYD
COLLECTION

PORCELAIN TILES
GRÈS CÉRAME
GRÉS PORCELÂNICO

SIZES



SURFACES

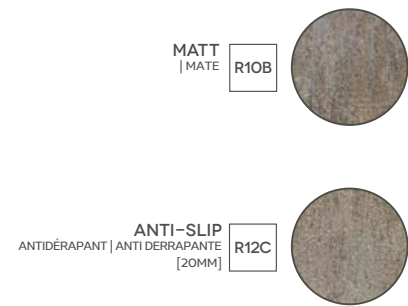

COLOR





M89106RT OXYD
890X890mm



597X597mm



MATT | MATE [R10B]
M17606
M17606RT

OXYD

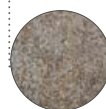

BORN • ECO



← 32% RECYCLED MATERIAL →

297X890mm [cut]



MATT | MATE [R10B]
M98506RT

890X890mm



MATT | MATE [R10B]
M89106RT

SKIRTING BOARD ROUNDED EDGE | PLINTHE AVEC BORD ARRONDI | RODAPÉ CORTADO

95X597mm

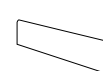

MATT | MATE
RM8706
RM8706RT

75X890mm



MATT | MATE
RM89006RT

GLUED ON MESH

297X297mm



OXYD
P50306

GLUED ON MESH

205x220mm



OXYD
P38306

GLUED ON MESH

300X350mm



OXYD
P35306

FLOOR CLASSIFICATION
CLASSIFICATION DE SOL
CLASSIFICAÇÃO DE PAVIMENTO



| | | | | | |
|------|------|--------------|----------|-------------|-------|
| Oxyd | Matt | 890x890x10,5 | M89106RT | U3 P3 E3 C2 | R10 B |
| Oxyd | Matt | 297x890x10,5 | M98506RT | U3 P3 E3 C2 | R10 B |
| Oxyd | Matt | 597x597x10,5 | M17606 | U3 P3 E3 C2 | R10 B |
| Oxyd | Matt | 597x597x10,5 | M17606RT | U3 P3 E3 C2 | R10 B |

PACKING & WEIGHTS
EMBALLAGE ET POIDS
EMBALAGENS & PESOS

| OXYD | FORMAT FORMATO | FINISHING FINITION ACABAMENTO | PIECES/BOX PIÈCES/BOÎTE PEÇAS/CAIXA | SQM/BOX m ² /BOÎTE m ² /CAIXA | BOXES/PALLET BOÎTES/PALETTE CAIXAS/PALETTE | SQM/PALLET m ² /PALETTE | WEIGHT/SQM POIDS/Kg/m ² PESO/Kg/m ² | WEIGHT/BOX POIDS/BOÎTE [Kg] PESO/CAIXA [Kg] | WEIGHT/PALLET POIDS/PALETTE [Kg] PESO/PALETTE [Kg] |
|-------------|--|--|--|--|---|--|--|--|---|
| | 890x890x10.5 597x597x9.2 597x597x9.2 297x890x10.5 | Matt Matt Matt Matt | 2,00 3,00 3,00 3,00 | 1,58 1,07 1,07 0,79 | 30 40 40 30 | 47,4 42,80 42,80 23,70 | 24,5 21,76 21,30 24,50 | 38,7 23,28 22,79 19,36 | 1176 951,33 931,64 604,65 |
| | | | | UNITS/BOX UNIDADES/BOÎTE UNIDADES/CAIXA | | UNITS/PALLET UNIDADES/PALETTE | | | |
| | Mesh Mesh Mesh | Matt Matt Matt | 8,00 9,00 10,00 | 8,00 9,00 10,00 | 1250 1111 45 | | 1,92 1,00 1,68 | 15,36 9,00 16,80 | |
| | Skirting Board Skirting Board Skirting Board | Matt Matt Matt | 20,00 20,00 13,00 | 20,00 20,00 13,00 | 48 48 48 | | 960,00 960,00 624,00 | 1,20 1,20 1,63 | 23,94 23,94 1169,12 1037,60 |

M17606RT OXYD
597X597mm



PK16606RT OXYD PARK
597X597mm [20mm]

OXYD PARK [20MM]

PORCELAIN TILES
GRÉS CÉRAME
GRÉS PORCELÂNICO

OXYD PARK

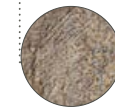

BORN · ECO



← 32% RECYCLED MATERIAL →

597X597mm



ANTI-SLIP | ANTIDERRAPANTE [R12C]
PK16606RT [20mm PARK]

COMPLEMENTARY PIECES PIÈCES COMPLÉMENTAIRES PEÇAS COMPLEMENTARES

297x597mm
Exterior Rounded Corners [2x]

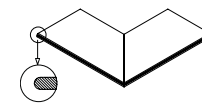

Oxyd - SK606BE

297x597mm
Interior Rounded Corners [2x]

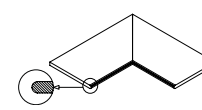

Oxyd - SK606BI

297x597mm
Rounded Step

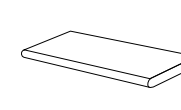

Oxyd - SK606B

297x597mm
Step With Riser Piece
[Right Corner]

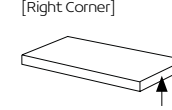

Oxyd - SK606CR

297x597mm
Step With Riser Piece
[Left Corner]

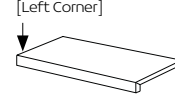

Oxyd - SK606CL

297x597mm
Step With Riser Piece

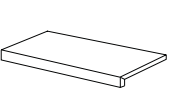

Oxyd - SK606C

147x597mm
Drain Grate Corner [2x]



Oxyd - SK606AG

147x597mm
Drain Grate



Oxyd - SK606G

297x597mm
Exterior Rounded Corner



Oxyd - SK606BRE

597x597mm
Interior Rounded Corner

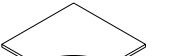

Oxyd - SK606BRI

FLOOR CLASSIFICATION CLASSIFICATION DE SOL CLASSIFICAÇÃO DE PAVIMENTO

Oxyd Park | Anti-Slip | 597x597x20 | PK16606RT | PEI IV | R12 C

PACKING & WEIGHTS EMBALLAGE ET POIDS EMBALAGENS & PESOS

| OXYD PARK | FORMAT FORMATO | FINISHING ACABAMENTO | PIECES/BOX PIÈCES/BOÎTE PEÇAS/CAIXA | SQM/BOX m ² /BOÎTE m ² /CAIXA | BOXES/PALLET BOÎTES/PALETTE CAIXAS/PALETE | SQM/PALLET m ² /PALETTE m ² /PALETE | WEIGHT/SQM POIDS Kg/m ² PESOKg/m ² | WEIGHT/BOX POIDS/BOÎTE [Kg] PESO/CAIXA [Kg] | WEIGHT/PALLET POIDS/PALETTE [Kg] PESO/PALETE [Kg] |
|-----------|-------------------|-------------------------|---|---|---|---|--|---|---|
| | 597x597x20 | Anti-Slip | 2,00 | 0,71 | 30 | 21,30 | 45,10 | 32,02 | 980,63 |