

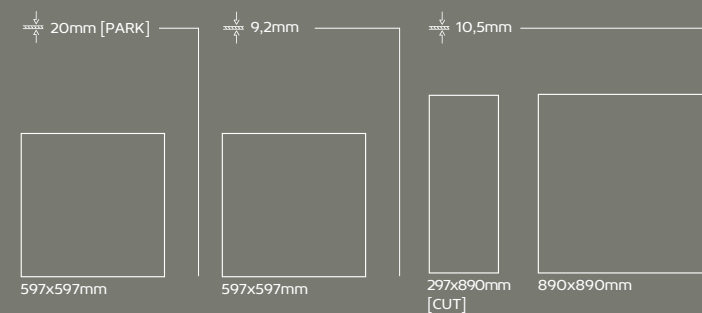

OXYD
COLLECTION

PORCELAIN TILES
GRÈS CÉRAME
GRÉS PORCELÂNICO

SIZES



SURFACES

MATT
MATE R10B



ANTI-SLIP
ANTIDÉRAPANT | ANTI DERRAPANTE [20MM] R12C

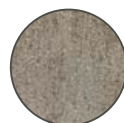

COLOR





M89106RT OXYD
890X890mm



597X597mm



MATT | MATE [R10B]
M17606
M17606RT

OXYD

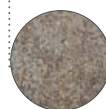

BORN • ECO



← 32% RECYCLED MATERIAL →

297X890mm [cut]



MATT | MATE [R10B]
M98506RT

890X890mm



MATT | MATE [R10B]
M89106RT

SKIRTING BOARD ROUNDED EDGE | PLINTHE AVEC BORD ARRONDI | RODAPÉ CORTADO

95X597mm

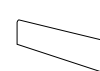

MATT | MATE
RM8706
RM8706RT

75X890mm

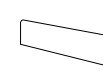

MATT | MATE
RM89006RT

GLUED ON MESH

297X297mm



OXYD
P50306

GLUED ON MESH

205x220mm



OXYD
P38306

GLUED ON MESH

300X350mm



OXYD
P35306

FLOOR CLASSIFICATION
CLASSIFICATION DE SOL
CLASSIFICAÇÃO DE PAVIMENTO



Oxyd	Matt	890x890x10,5	M89106RT	U3 P3 E3 C2	R10 B
Oxyd	Matt	297x890x10,5	M98506RT	U3 P3 E3 C2	R10 B
Oxyd	Matt	597x597x10,5	M17606	U3 P3 E3 C2	R10 B
Oxyd	Matt	597x597x10,5	M17606RT	U3 P3 E3 C2	R10 B

PACKING & WEIGHTS
EMBALLAGE ET POIDS
EMBALAGENS & PESOS

OXYD	FORMAT FORMATO	FINISHING FINITION ACABAMENTO	PIECES/BOX PIÈCES/BOÎTE PEÇAS/CAIXA	SQM/BOX m²/BOÎTE m²/CAIXA	BOXES/PALLET BOÎTES/PALETTE CAIXAS/PALETTE	SQM/PALLET m²/PALETTE	WEIGHT/SQM POIDS/Kg/m² PESO/Kg/m²	WEIGHT/BOX POIDS/BOÎTE [Kg] PESO/CAIXA [Kg]	WEIGHT/PALLET POIDS/PALETTE [Kg] PESO/PALETTE [Kg]
	890x890x10.5 597x597x9.2 597x597x9.2 297x890x10.5	Matt Matt Matt Matt	2,00 3,00 3,00 3,00	1,58 1,07 1,07 0,79	30 40 40 30	47,4 42,80 42,80 23,70	24,5 21,76 21,30 24,50	38,7 23,28 22,79 19,36	1176 951,33 931,64 604,65
				UNITS/BOX UNIDADES/BOÎTE UNIDADES/CAIXA		UNITS/PALLET UNIDADES/PALETTE			
	Mesh Mesh Mesh	Matt Matt Matt	8,00 9,00 10,00	8,00 9,00 10,00	1250 1111 45		1,92 1,00 1,68	15,36 9,00 16,80	
	Skirting Board Skirting Board Skirting Board	Matt Matt Matt	20,00 20,00 13,00	20,00 20,00 13,00	48 48 48	450,00 960,00 624,00	1,20 1,20 1,63	23,94 23,94 21,20	776,00 1169,12 1169,12 1037,60

M17606RT OXYD
597X597mm



PK16606RT OXYD PARK
597X597mm [20mm]

OXYD PARK [20MM]

PORCELAIN TILES
GRÉS CÉRAME
GRÉS PORCELÂNICO

OXYD PARK

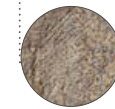

BORN • ECO



← 32% RECYCLED MATERIAL →

597X597mm



ANTI-SLIP | ANTIDERRAPANTE [R12C]
PK16606RT [20mm PARK]

COMPLEMENTARY PIECES PIÈCES COMPLÉMENTAIRES PEÇAS COMPLEMENTARES

297x597mm
Exterior Rounded Corners [2x]

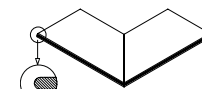

Oxyd - SK606BE

297x597mm
Interior Rounded Corners [2x]

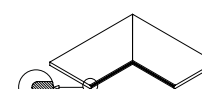

Oxyd - SK606BI

297x597mm
Rounded Step

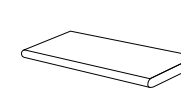

Oxyd - SK606B

297x597mm
Step With Riser Piece
[Right Corner]

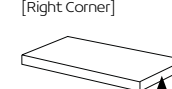

Oxyd - SK606CR

297x597mm
Step With Riser Piece
[Left Corner]

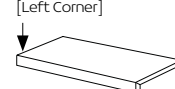

Oxyd - SK606CL

297x597mm
Step With Riser Piece

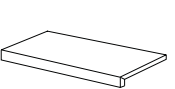

Oxyd - SK606C

147x597mm
Drain Grate Corner [2x]

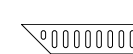

Oxyd - SK606AG

147x597mm
Drain Grate

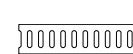

Oxyd - SK606G

297x297mm
Exterior Rounded Corner



Oxyd - SK606BRE

597x597mm
Interior Rounded Corner

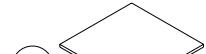

Oxyd - SK606BRI

FLOOR CLASSIFICATION CLASSIFICATION DE SOL CLASSIFICAÇÃO DE PAVIMENTO

Oxyd Park | Anti-Slip | 597x597x20 | PK16606RT | PEI IV | R12 C

PACKING & WEIGHTS EMBALLAGE ET POIDS EMBALAGENS & PESOS

OXYD PARK	FORMAT FORMATO	FINISHING ACABAMENTO	PIECES/BOX PIÈCES/BOÎTE PEÇAS/CAIXA	SQM/BOX m ² /BOÎTE m ² /CAIXA	BOXES/PALLET BOÎTES/PALETTE CAIXAS/PALETE	SQM/PALLET m ² /PALETTE	WEIGHT/SQM POIDS Kg/m ² PESOKg/m ²	WEIGHT/BOX POIDS/BOÎTE [Kg] PESO/CAIXA [Kg]	WEIGHT/PALLET POIDS/PALETTE [Kg] PESO/PALETE [Kg]
	597x597x20	Anti-Slip	2,00	0,71	30	21,30	45,10	32,02	980,63